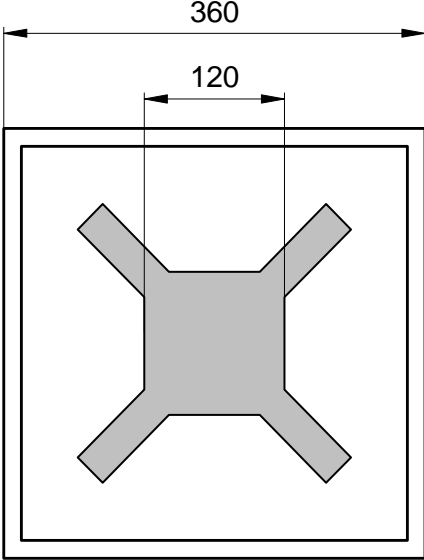

Radiation	Type	Technology	Electrodes
Infrared	DDH	AlGaAs/AlGaAs	P (anode) up

 <p style="text-align: center;">LED-05</p>	typ. dimensions (μm)	
	<u>typ. thickness</u> 180 μm <u>anode</u> gold alloy, 1.5 μm <u>cathode</u> gold alloy, 0.5 μm structured, 25% covered	

Optical and Electrical Characteristics

$T_{amb} = 25^{\circ}\text{C}$, unless otherwise specified

Parameter	Test conditions	Symbol	Min	Typ	Max	Unit
Forward voltage	$I_F = 20 \text{ mA}$	V_F		1.3	1.7	V
Reverse voltage	$I_R = 100 \text{ μA}$	V_R	5			V
Radiant power ¹	$I_F = 20 \text{ mA}$	Φ_e	2.5	3.5		mW
Peak wavelength	$I_F = 20 \text{ mA}$	λ_p	865	880	890	nm
Spectral bandwidth at 50%	$I_F = 20 \text{ mA}$	$\Delta\lambda_{0.5}$		35		nm
Switching time	$I_F = 20 \text{ mA}$	t_r, t_f		25		ns

¹Measured on bare chip on TO-18 header with JENOPTIK Polymer Systems equipment

Labeling

Type	Lot N°	$\Phi_e(\text{typ})$ [mW]	$V_F(\text{typ})$ [V]	Quantity
ELC-880-17-3				

Packing: Chips on adhesive film with wire-bond side on top

Environmental		Symbol	Min	Typ	Max	Unit
Storage Temperature	on Blue Tape	T_{STG}	15		30	$^{\circ}\text{C}$
Storage Relative Humidity	on Blue Tape	RH_{STG}	40		75	% RH
Storage Time	on Blue Tape	t_{STG}			1	year

We reserve the right to make changes to improve technical design and may do so without further notice.

Parameters can vary in different applications. All operating parameters must be validated for each customer application by the customer.

JENOPTIK Polymer Systems GmbH, D-12555 Berlin, Köpenicker Str.325 b, Haus 201

Tel.: +49-30-6576 2543, Fax : +49-30-6576 2545